



SABIANA
IL CLIMA AMICO



A leading brand of **AFG**

domoticus
el clima perfecto

Jetstream Induction Flow Optimizer

The Atlas unit heaters can be supplied with the innovative **JETSTREAM** induction flow optimiser, in the manual version or the motorised version for wall-hung or ceiling installation. The lower outlet temperature of the air from the units means less stratification of the hot air in the building and less operating time for the same ambient temperature. In addition, the increased air throw means greater uniformity of the temperature at floor level, with an expansion of the comfort zone, and consequently the possibility to install smaller and more silent appliances.



Technical characteristics:

The use of the **JETSTREAM** induction flow optimizer has the following advantages:

a) Energy saving:

- reduced hot air stratification within the building.
- reduced operating time of the units with the same ambient temperature.

Energy saving varies between a minimum of 5% and a maximum of 15%, with maximum amortization in two seasons.



b) Environment comfort advantages:

- increased floor-temperature uniformity with greater comfort area.
- possibility to install smaller and quieter units, due to the increase of the throw.

Air flow produced by a unit heater WITHOUT induction flow optimizer

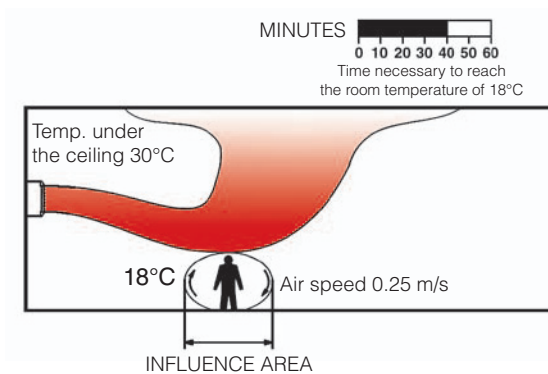

Air flow produced by a unit heater WITH induction flow optimizer

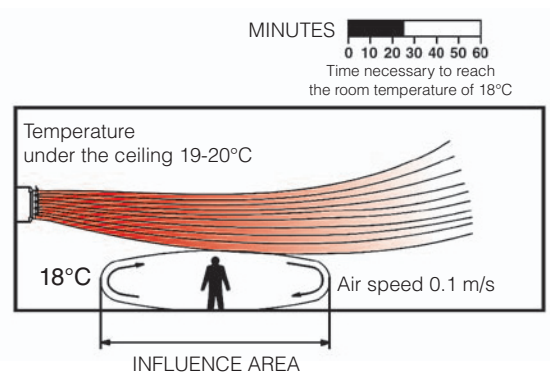

Four versions are available:

- Manual for wall installation (all sizes)
- Manual for ceiling installation (all sizes)
- Motorized for wall installation (sizes 1÷7 only)
- Motorized for ceiling installation (all sizes)

The manually controlled version calls for manual orientation of the fins and for them to be locked using a special threaded rod.

The motorized version is supplied with single phase motor that can be controlled by the remote switch.

Dimensions and Weight

O (HORIZONTAL DISCHARGE)

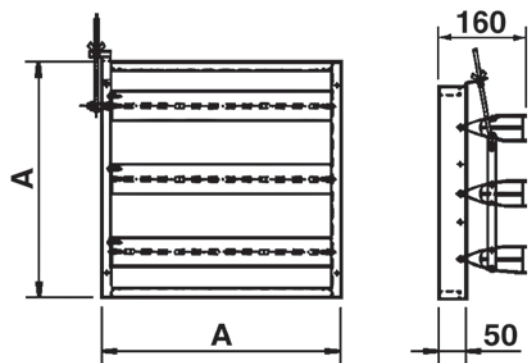

MODEL		A	WEIGHT
		mm	Kg
O - 1	V - 1	368	1,4
O - 2	V - 2	422	1,7
O - 3	V - 3	476	1,8
O - 4	V - 4	530	2,0
O - 5	V - 5	584	2,2
O - 6	V - 6	638	2,4
O - 7	V - 7	793	2,6
O - 8	V - 8	900	3,0
O - 9	V - 9	1010	3,4
O - 10	V - 10	1117	3,7

V (VERTICAL DISCHARGE)

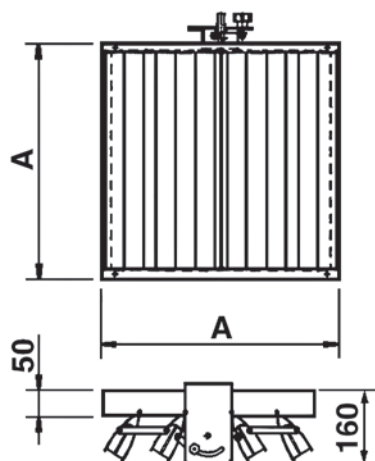

Controls

Remote switch

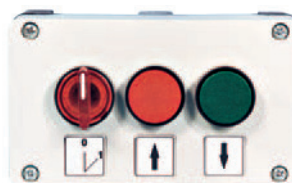

Mounting heights and Air throw

a) Wall installation for horizontal discharge:

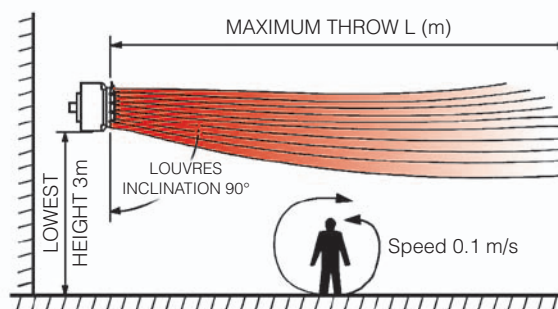

SABIANA UNIT HEATER SIZE	MAXIMUM THROW L (m)					
	WITHOUT JETSTREAM			WITH JETSTREAM		
	4P	6P	8P	4P	6P	8P
0	8	5,5	-	13	9	-
1	11	7,5	-	16	13	-
2	14	10	-	19	15	-
3	16	12	-	21	15	-
4	20	15	-	26	18	-
5	25	18	-	31	23	-
6	-	24	18	-	29	23
7	-	26	20	-	32	25
8	-	28	21	-	34	26
9	-	30	22	-	37	28

b) Ceiling installation for vertical discharge:

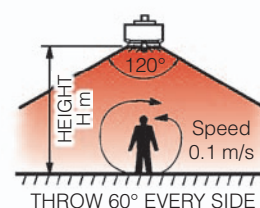
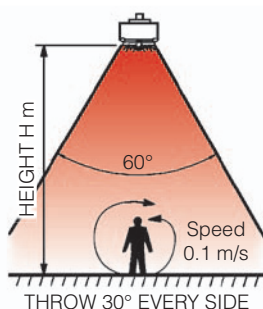

SABIANA UNIT HEATER SIZE	INSTALLATION HEIGHT H (m)								
	WITHOUT JETSTREAM			WITH JETSTREAM AT 60°			WITH JETSTREAM AT 120°		
	4P	6P	8P	4P	6P	8P	4P	6P	8P
0	4	3	-	5,5	4	-	4	3	-
1	4,5	3,5	-	8	6,5	-	5	4	-
2	5	4	-	11	8	-	6,5	5,5	-
3	5,5	4,5	-	12	9	-	6,5	5,5	-
4	6	5	-	13	10	-	7	6	-
5	7	6	-	14	12	-	8	7	-
6	-	7	6	-	13	11	-	8	7
7	-	9	7	-	15	12	-	10	8
8	-	11	8	-	18	13	-	13	9
9	-	12	9	-	19	14	-	14	10

The descriptions and illustrations provided in this publication are not binding: Sabiana reserves the right, whilst maintaining the essential characteristics of the types described and illustrated, to make, at any time, without the requirement to promptly update this piece of literature, any changes that it considers useful for the purpose of improvement or for any other manufacturing or commercial requirements.



SABIANA
IL CLIMA AMICO

A leading brand of  **AFG**

domoticus
el clima perfecto

Av. 20 de octubre, Nro. 2572. La Paz - Bolivia

Tel. 2 972105 • Cel. (+591) 70792122

www.domoticus.com.bo

JE-LT-EN-07-14